

PBFA9X15-X Push Button Frame Adapter, 9" x 15"

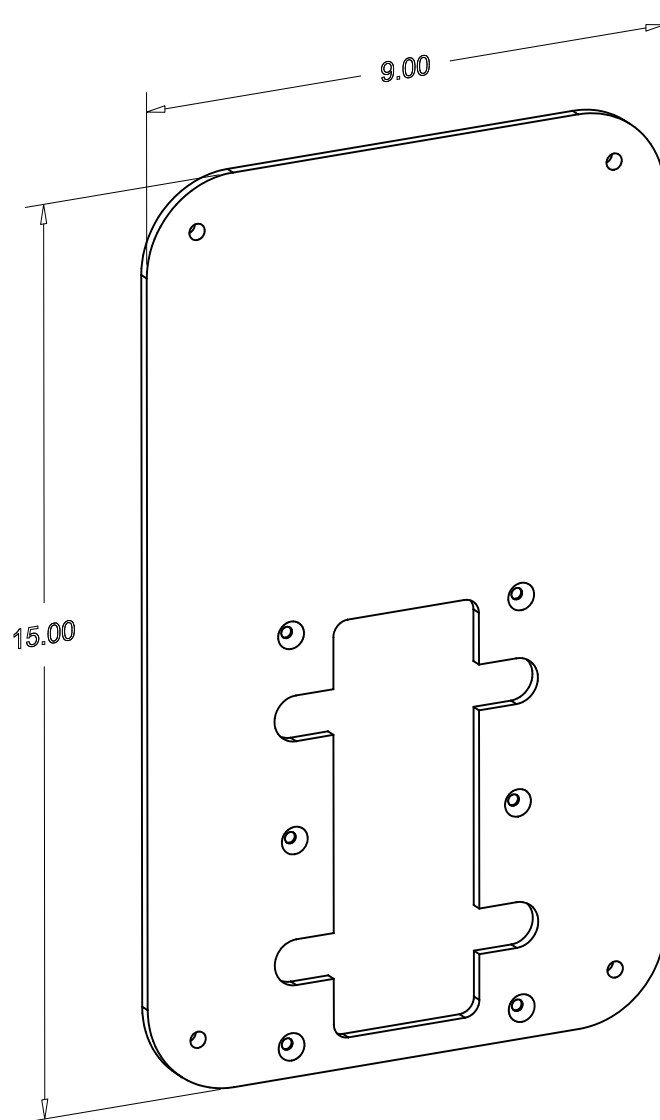

Polara Engineering's 9" x 15" Push Button Frame Adapter is designed to be attached to Polara's PBF5X7-X Push Button Frame, for mounting 9" x 15" crosswalk signs. These adapters can also be used on 2 wire and 4 wire Navigators. Their cast aluminum structure and powder coat finish provides a very strong and attractive mount for crosswalk signs.

Polara's Frame Adapter is unique from our competitors' in the fact that other companies typically drill and tap the screw holes directly into the aluminum. When a dissimilar metal screw is installed to hold the sign, bi-metal corrosion occurs between the screw and aluminum. When the screws need to be removed they often break or strip out the threads. This renders the adapter useless requiring a new adapter to be installed or significant time must be spent drilling and installing inserts or tapping new holes.

Polara uses high quality stainless steel threaded inserts that, when used with 1/4-20 stainless steel screws, eliminate the bi-metal corrosion problem.

To designate color, replace the "X" in the part number with:

- "B" for Black
- "G" for Green
- "Y" for Yellow

Material: Aluminum